

ZANUSSI

 Electrolux

WASHER-DRYER

WJD 1667 W

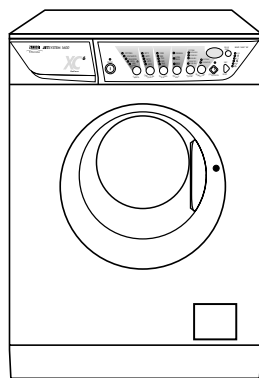



Important Safety Information

It is most important that this instruction book should be retained with the appliance for future reference. Should the appliance be sold or transferred to another owner, or should you move house and leave the appliance, always ensure that the book is supplied with the appliance in order that the new owner can get to know the functioning of the appliance and the relevant warnings.

These warnings have been provided in the interest of safety. You **MUST** read them carefully before installing or using the appliance.

Installation

- This appliance is heavy. Care should be taken when moving it.
- It is dangerous to alter the specifications or attempt to modify this product in any way.
- All packing and transit bolts must be removed before use. Serious damage can occur to the product and to property if this is not adhered to. See relevant section in instructions.
- Any plumbing work required to install this appliance should be carried out by a qualified plumber or competent person.
- Any electrical work required to install this appliance should be carried out by a qualified electrician or competent person.
- Care must be taken to ensure that the appliance does not stand on the electrical supply cable.
- If the machine is situated on a carpeted floor, please adjust the feet in order to allow air to circulate freely.

Child Safety

- This appliance is designed to be operated by adults. Children should not be allowed to tamper with the controls or play with the product.
- Pets and children have been known to climb into washer-dryers. Please check your drum before use.
- The glass door becomes very hot during the washing and drying cycle. Keep children away from the vicinity of the appliance whilst it is in operation.
- Keep all packaging well away from children.
- Keep all detergents in a safe place out of children's reach.

Use

- Always unplug the appliance and turn off the water supply after use.
- Do not overload the appliance. See relevant section in the instruction book.
- Only wash and dry fabrics which are designed to be machine washed and dried. If in doubt, consult the care label on the clothes.
- Before washing, ensure that all pockets are empty and buttons and zips are fastened. Avoid washing

frayed or torn articles and treat stains such as paint, ink, rust, and grass before washing. Underwired bras must NOT be machine washed.

- Any objects such as coins, safety pins, nails, screws, stones or any other hard, sharp material can cause extensive damage and must not be placed into the machine.
- Garments which have been in contact with volatile petroleum products should not be machine washed. If volatile cleaning fluids are used, care should be taken to ensure that the fluid is removed from the garment before placing in the machine.
- Wash small items such as socks, laces, washable belts etc in a washing bag or pillow case as it is possible for such items to slip down between the tub and the inner drum.
- Only use the advised quantities of fabric softener. Damage to the fabric can ensue if you over-fill. Refer to the manufacturer's recommendations of quantities.
- As some duvets and eiderdowns should be washed/dried in large commercial machines because of their bulk, please check with the manufacturer of the item before washing in a domestic machine.
- The users should always check that they have not left their gas lighters (disposable or otherwise) in their clothing.
- Never tumble dry items that have had contact with chemicals such as dry cleaning fluid. These are of a volatile nature and could cause an explosion. Only tumble dry items which have been washed in water or require airing.
- Plastic detergent dispensers should not remain in the drum during the drying cycle, as the plastic used is not designed to withstand the heat. If you wish to wash-through-to-dry you should use the conventional detergent dispenser drawer.
- Leave the porthole door slightly ajar between washes to preserve the door seal.
- Under no circumstances should you attempt to repair the machine yourself. Repairs carried out by inexperienced persons may cause injury or serious malfunctioning. Contact your local Service Force Centre. Always insist on genuine Zanussi spare parts.

Contents

For the User

| | |
|--|-------|
| Important Safety Information | 2 |
| Your New Washer-Dryer | 4 |
| Description of the Appliance | 5 |
| Door locked light | 5 |
| Detergent dispenser drawer | 5 |
| Child safety feature | 5 |
| The Control Panel | 6-10 |
| Turning the acoustic signal off | 6 |
| Operating sequence | 11-14 |
| Washing | 11 |
| Load the laundry | 11 |
| Measure out the detergent | 11 |
| Measure out the fabric softener | 11 |
| Switch the machine on | 11 |
| Select the required programme/fabric | 11 |
| Select the temperature | 12 |
| Select the spin speed or the NIGHT WASH option | 12 |
| Select the desired options | 12 |
| Select the DELAY START | 12 |
| Start the programme | 12 |
| How to change a programme during its cycle | 12-13 |
| How to cancel a programme during its cycle | 13 |
| How to open the door during the cycle of a programme | 13 |
| End of programme | 13 |
| Drying 2.5 kg of cotton | 14 |
| Autodrying 2 kg of synthetics | 14 |
| Washing and Drying Hints | 15 |
| Which detergent to use?.... | 16 |
| And in which form? | 16 |
| Wash Care Symbols | 17 |
| Washing Programmes | 18 |

| | |
|---------------------------------|-------|
| Drying Programmes | 19 |
| Maintenance and Cleaning | 20-21 |
| Descaling | 20 |
| After each wash | 20 |
| Maintenance wash | 20 |
| External cleaning | 20 |
| Cleaning the dispenser drawer | 20 |
| Cleaning the drawer recess | 20 |
| Cleaning the filter | 20-21 |
| The dangers of freezing | 21 |
| Something Not Working | 22-23 |
| Service and Spare Parts | 23 |
| Guarantee Conditions | 24 |

For the Installer

| | |
|------------------------------------|-------|
| Installation Instructions | 25 |
| Technical Specifications | 25 |
| Unpacking | 26 |
| Positioning | 26 |
| Water inlet | 26-27 |
| Water drainage | 27 |
| Levelling | 28 |
| Special conditions | 28 |
| In the interest of the environment | 28 |
| Electrical connection | 29 |

Guide to use the Instruction Book

The following symbols will be found in the text to guide you throughout the instructions:



Safety instructions



Hints and tips



Environmental information

Your New Washer-Dryer

Your new washer-dryer, fitted with the Zanussi “JET SYSTEM”, meets all modern requirements for effective treatment of laundry with low water, energy and detergent consumption.

Even small loads are washed “economically” because the amount of water used is regulated automatically according to the load and type of fabric.

It is gentle with your laundry, simple to use and easy to care for.

- **The special wool programme** with its new delicate wash system treats your woollens with extreme care.
- **The anti-unbalance device** ensures that the machine remains stable when spinning.
- **Automatic cooling of the wash water to 60°C** before draining, with the 90°C programme. This reduces thermal shock to fabrics, helping to prevent creasing.
- **The two drying programmes** will give your wash that soft, relaxed feel whatever the weather.

Ecological hints

To save water and energy and help protect the environment, we recommend that you follow these hints:

- Adjust the quantity of detergent according to the hardness of your water supply, the amount of laundry and the degree of soiling.
- Select a “Quick” programme for lightly soiled laundry.
- A programme without prewash is sufficient for normally soiled laundry.
- Try to load the maximum drying capacity of the machine as small loads are **uneconomical**.
- Always load well spun laundry. The higher the spin speed, the lower the electricity consumption and the shorter the drying times.

Important

Your machine is fitted with a balance control device, which ensures the machine is stable during the spin.

If the wash load appears not to have been spun sufficiently at the end of the wash cycle, because it is not evenly distributed in the drum, the balance control device may have operated. It will therefore be necessary to redistribute the wash load manually and select a spin programme. For more detailed information see the section headed "Something Not Working".

In the interest of the environment

- Materials marked with the symbol  are recyclable.
- Check with your local Council or Environmental Health Office to see if there are facilities in your area for re-cycling this appliance.
- When the appliance is to be scrapped, cut off the power supply cable and make the door lock device unusable to prevent young children from being trapped inside.
- Help to keep your country tidy - use authorised disposal sites for your old appliance.

**How do we help to protect the environment?
We use recycled paper!**

Description of the Appliance

- 1 Detergent dispenser drawer
- 2 Control Panel
- 3 Door locked light
- 4 Door opening handle
- 5 Filter
- 6 Adjustable feet

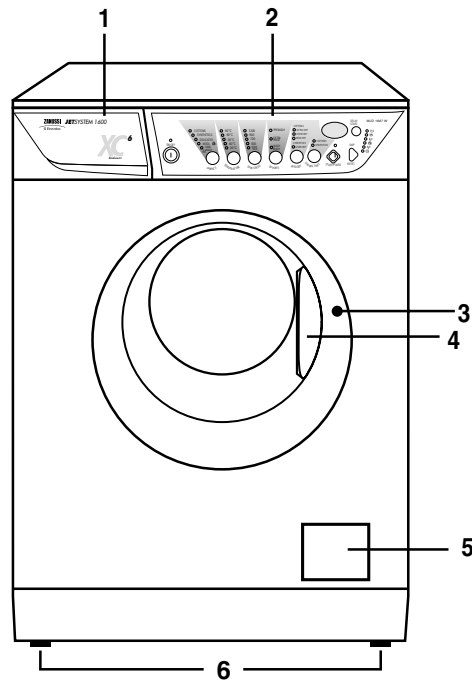



Door locked light

It stays on during the whole programme indicating that the door is locked.

When the light goes out, the door can be opened (see page 13).

Detergent dispenser drawer

-  Prewash
-  Main wash
-  Fabric softener

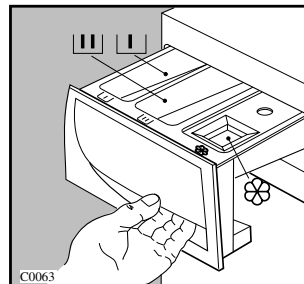

Child safety feature

This machine incorporates a special child safety feature to prevent small children from being trapped inside the machine.

To activate this device, rotate the button (without pressing it) inside the door clockwise until the groove is horizontal. If necessary use a coin.

To disable this device and restore the possibility of closing the door, rotate the button anti-clockwise until the groove is vertical.

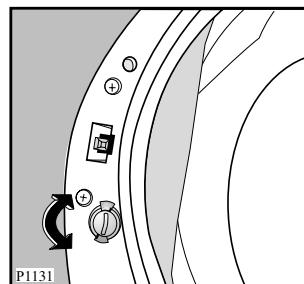

The Control Panel

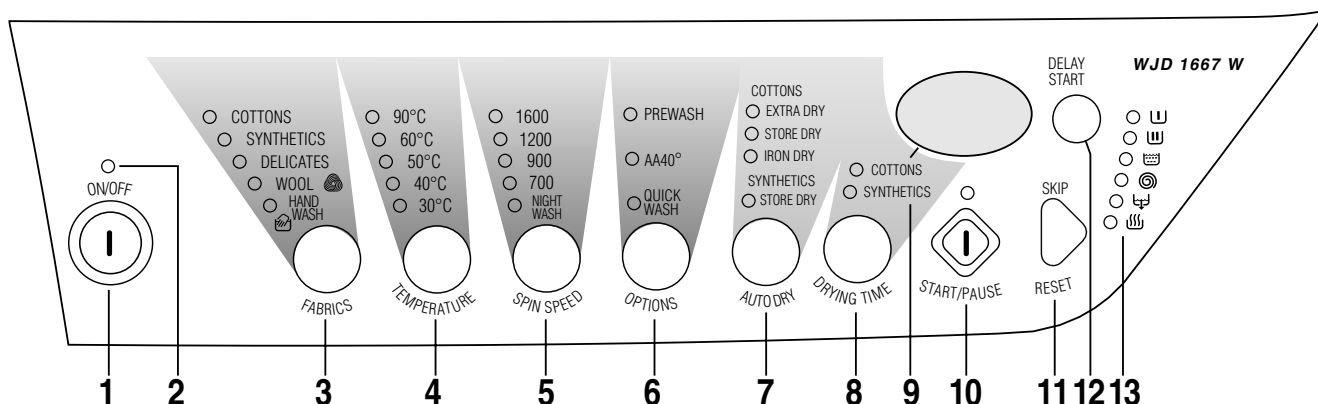

1 ON/OFF button

Press this button to switch the machine on. The display (9) will show three blinking dashes or a blinking zero. You will find more detailed explanations on pages 7-8 (see “DISPLAY”).

Press the ON/OFF button again to switch the machine off.

2 MAINS-ON light

This light is connected to the ON/OFF button. It lights up when you press the button, and goes out when you press it again.

3 FABRICS button

Press this button repeatedly to select the programme on the basis of the type of laundry to be washed. The light relevant to the selected programme will light up. The machine will propose a temperature and automatically select the maximum spin value provided for the programme you have chosen. You can change these values by operating buttons 4 and 5.

Hand wash

When you select this programme, you obtain a particularly delicate washing, suitable for articles of clothing whose label indicates that they must be hand-washed  .

4 TEMPERATURE button

Press this button repeatedly to increase or decrease the temperature, if you want your laundry to be washed at a temperature different from the one proposed by the machine. The relevant light will light up.

Maximum temperatures are 90°C for cotton, 60°C for synthetic fabrics, 40°C for delicate fabrics, wool and fabrics to be hand-washed (HAND WASH programme).

Important!

By pressing the TEMPERATURE and SPIN SPEED buttons simultaneously for 3 seconds, the acoustic signal is deactivated at the end of the cycle, when selecting the programmes and in case of an incorrect option selection.

By pressing these 2 buttons again the acoustic signal is reactivated.

5 SPIN SPEED button

Press this button repeatedly to change the spin speed, if you want your laundry to be spun at a speed different from the one proposed by the machine. The relevant light will light up.

Maximum speeds are:

- for cotton: 1,600 rpm;
- for synthetic fabrics, wool, and fabrics to be hand-washed: 900 rpm;
- for delicate fabrics: 700 rpm.

NIGHT WASH position : when you choose this option, the machine will not drain the water of the last rinse, so as not to wrinkle the laundry.

As all spinning phases are suppressed, this washing cycle is very quiet and it can be useful at night or in times with a more economical power rate.

On cotton and synthetic programmes the rinses will be performed with more water.

At the end of the cycle, the light corresponding to the option NIGHT WASH is on and the START/PAUSE button light will flash, to indicate that the water must be

drained. A static zero will appear on the display. To complete the cycle, choose one of the following options:

- **Draining and spin:**

- **Press the START/PAUSE button.** The machine will drain the water, then spin the laundry at the maximum speed provided for the selected programme.

- **Select spin speed** by means of button 5, and press the START/PAUSE button.

- **Drain only**

- Press the SKIP/RESET button **once**, so as to cause the DRAIN light  to light up, then press the START/PAUSE button.

Important! If you accidentally press the SKIP/RESET button more than once, the display will show **three blinking dashes**. To cause the washing machine to drain the water, select any washing programme by means of the FABRIC button, then press SKIP/RESET **three times** in order to select the DRAIN position (only the DRAIN light will remain lit).

The NIGHT WASH option **cannot** be selected for the automatic WASHING & DRYING programme.

6 OPTIONS button

Press this button to select the following options:

- **PREWASH:** select this option if you wish your laundry to be prewashed before the main wash (**not available for wool and hand-wash cycle**).

The prewash ends with a short spin at 650 rpm in programmes for cotton and synthetic fabrics, whereas in the programme for delicate fabrics the water is only drained.

- **AA 40°:** this option can be selected for cottons and synthetics lightly or normally soiled with a temperature of 40°C or higher.

If you select a temperature of 40°C, the machine will prolong the time at 40°C in the washing phase; this will allow an A class in energy efficiency and washing performance to be achieved.

If you select 90°C and press the **AA 40°** button, the washing temperature will be reduced from 90°C to 60°C.

If you select 50°C or 60°C and press the **AA 40°** button, the washing temperature will be reduced to 40°C. In both cases the washing time will be prolonged.

- **QUICK:** select this option for laundry that is only slightly soiled (**not for wool and HAND WASH programme**).

The washing time will be reduced according to the type of fabric and the selected temperature.

The PREWASH, AA 40° and QUICK options **cannot** be selected together.

7 AUTO DRY button



This button allows you to choose the required degree of drying for cottons and synthetics:

- Extra dry (only for cottons)
- Store dry (cottons and synthetics)
- Iron dry (only for cottons)

The drying time is automatically adjusted by the machine: the laundry will be dried to the selected degree of dryness.

8 DRYING TIME button

By depressing this button you can select a timed programme for cotton or synthetics, the relevant light illuminates. To select “cottons” you have to push the button for about 2 seconds. To select the drying time push the button until the time you want appears in the display according to the fabrics (cotton or synthetics) you have to dry.

- For COTTON you can select a drying time from 10 minutes to 2 hours and 10 minutes ().
- For SYNTHETICS you can select a drying time from 10 minutes to 1 hours and 40 minutes (.

Every time you press the button the time increases, by 5 mins.

9 Display

The following pieces of information are shown on the display:

- **Three blinking dashes**, when a programme is cancelled by means of the SKIP/RESET button.

The three blinking dashes will also appear when you press the ON/OFF button to switch the machine on, if the previously selected cycle has been erased.

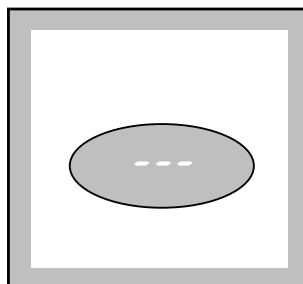

- **Duration of washing programme** in hours and minutes, after you have selected a programme.

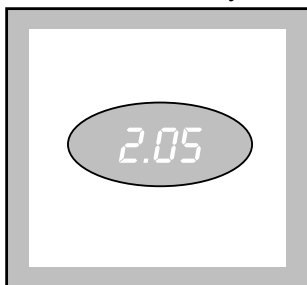

While the programme is running (after you have pressed the START/PAUSE button), the displayed time value decreases by one unit every minute.

- **Selected drying time** in minutes or hours and minutes.

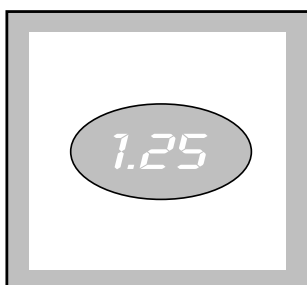

After the programme has started the time remaining is updated every minute.

- **The washing machine has stopped with water in the tub**, at the end of a programme with the NIGHT WASH option: this is indicated by a **static zero**.
- **The washing machine has completed the programme**: this is indicated by a **blinking zero**. At the same time, the door locked light goes out. The zero will reappear when you switch the washing machine on, unless the previous programme has been erased by means of the SKIP RESET button.

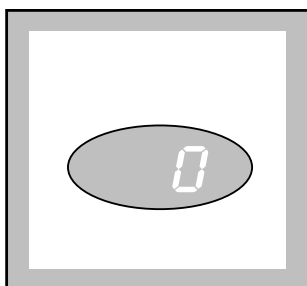

Important!

The first time you use the washing machine, when you switch it on, it may display a blinking zero and give an audible warning signal. This is due to the fact that the

washing machine has performed a washing cycle during the manufacturer's inspection tests, and this cycle has not been erased after its completion.

- **Delay start**, a time value indicated in hours and selected by means of the relevant button.

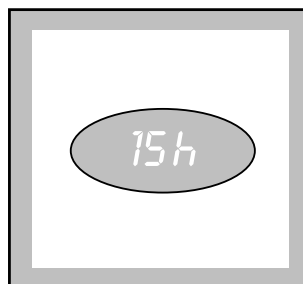

The delay time is displayed for 3 seconds, then the duration of the selected programme reappears. After you have pressed the START/PAUSE button, the countdown begins, and the delay time value decreases by one unit every hour. You can delay the start of the selected programme by up to 24 hours in one hour intervals.

- **An incorrect option selection has been made**: this is indicated by the message **Err** when a function incompatible with the current programme is selected.

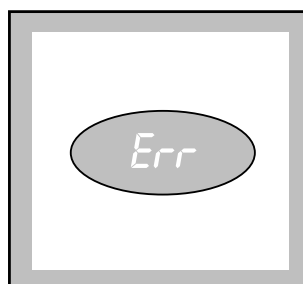

The incorrect selection is also indicated by an audible warning signal.

- **An alarm code** indicates a fault in the machine operation (see the relevant chapter on page 22-23).

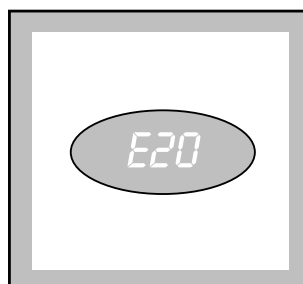

I O START/PAUSE button

This button has three functions:

- **Start:** after you have selected the desired programme and options, press this button to start the machine. The light above the button will stop flashing and remain lit. If you have selected a delay time by means of button 12, the countdown will begin and will be shown on the display.

- **Pause:** when you press this button again, the programme in progress is interrupted. The light above the button will start flashing. To restart the programme, press the button again.

When you PAUSE the cycle, the DOOR LOCKED light goes out, and it becomes possible to open the door, provided

- the machine is not in the heating or drying phase;
- the level of the water is not high;
- the drum is not turning.

Important! You must set the washing machine to PAUSE before you make any change in the programme in progress.

- **Draining of water and spinning** after the execution of programmes with the NIGHT WASH option.

I I SKIP/RESET button

This button performs two functions:

- Clears the memory
- Selects special programmes

At the end of every programme the RESET button must be pressed once or repeatedly to clear the programme memory. This will be confirmed by three dashes, flashing in the display.

If the previous programme is not cleared, the display will show a “E” flashing and an audible signal will sound, when you switch the machine on.

Selecting a special programme:

A wash programme must be selected in the normal way. (START button not pressed)

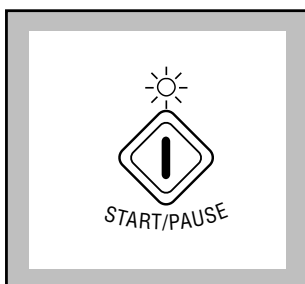

A normal wash cycle consists of the following phases, **Wash - Rinses - Spin** and is confirmed by the illumination of the corresponding LED,s.

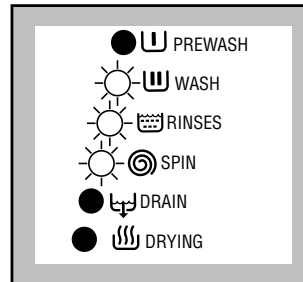

To select **rinse & spin**, press the SKIP button once, the **wash** LED goes out.

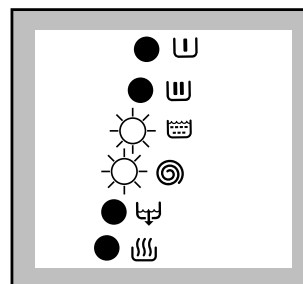

To select **spin** only, press the SKIP button twice. The **wash & rinse** LED,s go out.

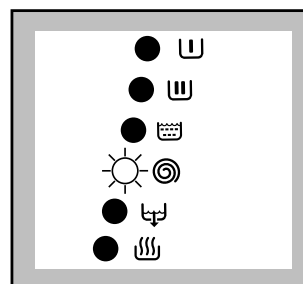

To select **Drain** press the SKIP button three times, the **wash - rinse - spin** LED,s go out.

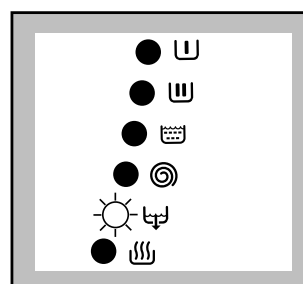

If you wish to cancel or advance the running programme to the required phase, PAUSE the cycle and then press the SKIP button as previously described.

I2 DELAY START button

This button makes it possible to delay the starting of the programme by up to 24 hours. The delay you have selected is shown on the display for about 3 seconds; afterwards, the duration of the programme reappears. You must select this option **after** you have set the programme and **before** you press the START/PAUSE button.

The time value shown on the display will decrease by one unit every hour.

You can change the delay time at any moment, before you press the START/PAUSE button.

If you have already pressed the START/PAUSE button, and you wish to **change** or **cancel** the delay time, proceed as follows:

- set the machine to PAUSE by pressing the START/PAUSE button;
- press the DELAY START button until the display shows the desired delay time or
- press the DELAY START button once, to erase the delay time. The display will indicate “0h”.
- press the START/PAUSE button again.

Important!

The door will be locked throughout the delay time (DOOR LOCKED light lit).

If you need to open the door, you must first set the machine to PAUSE by pressing the START/PAUSE button. After you have closed the door, press the START/PAUSE button again.

I3 Programme phase indicator lights

When you select a programme, the lights relevant to the phases that form the programme light up.

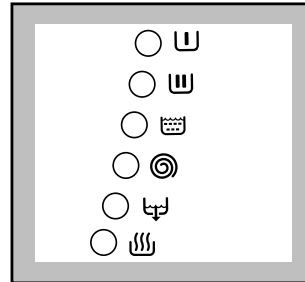

After you have started the programme, only the light relevant to the phase that is currently being carried out will remain lit.

i Operating Sequence

WASHING

Before the first wash, we recommend that you run a cotton cycle at 60°C, without any laundry in the machine, to remove any manufacturing residue from the drum and tub.

Pour 1/2 a measure of detergent into the dispenser drawer and start the machine.

1. Load the laundry

Open the door.

Place the laundry in the drum, one item at a time, shaking them out as much as possible.

Close the door.

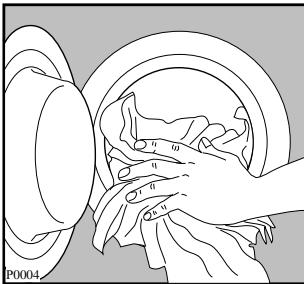

2. Measure out the detergent

Pull out the dispenser drawer until it stops. Measure out the amount of detergent required and pour it into the main wash compartment .

If you wish to carry out the prewash, pour detergent into the appropriate compartment marked .

3. Measure out the fabric softener

If required, pour fabric softener into the compartment marked , without exceeding the «MAX» mark.

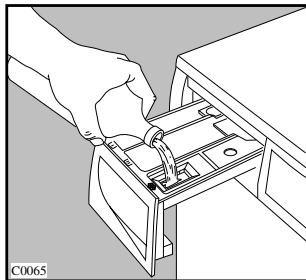
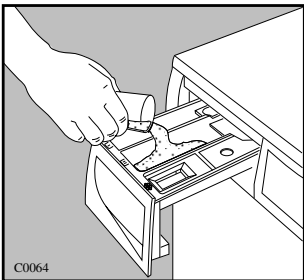

Close the drawer gently.

4. Switch the machine on

Press the ON/OFF button to switch the machine on. The display will show three blinking dashes or a blinking zero. The light above the button will light up.

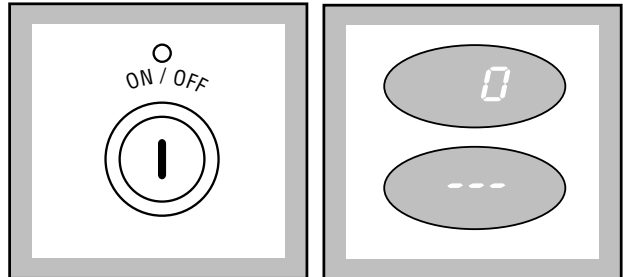

5. Select the desired programme/fabric

Press the FABRICS button repeatedly, in order to select the desired programme/fabric. The relevant light will light up.

The lights relevant to the phases that form the programme will light up.

The display will show the duration of the selected programme, calculated on the basis of the maximum load for each type of fabric. The START/PAUSE button light will start flashing.

If the load of laundry to be washed is small, at the beginning of the cycle the display will still indicate the duration relevant to the maximum load. The duration value will be gradually adjusted during the execution of the cycle.

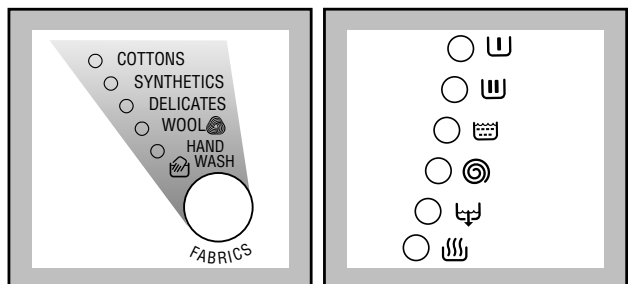

6. Select the temperature

Press the TEMPERATURE button if you wish to select a temperature value different from the one proposed by the washing machine.

The relevant light will light up.

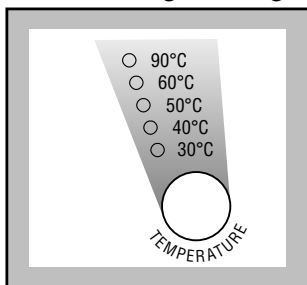

7. Select the spin speed or the NIGHT WASH option

Press the SPIN SPEED button repeatedly, in order to select the desired spin speed or the NIGHT WASH option. The relevant light will light up.

If you select the NIGHT WASH option, the machine will stop at the end of the programme with the water still in the tub.

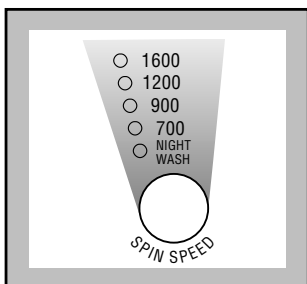

8. Select the desired options

If your laundry is very dirty, it may be advisable to select the PREWASH option.

If your laundry is lightly or normally soiled and it is necessary to prolong the washing time, select the AA40° option.

If your laundry is only slightly soiled, select the QUICK option.

The relevant light illuminates.

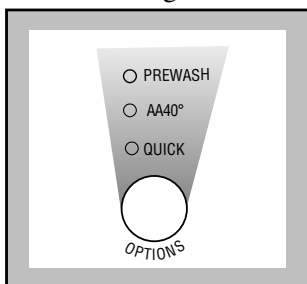

9. Select the DELAY START

Before you start the programme, if you wish the starting to be delayed, press the DELAY START button repeatedly, or keep it pressed, to select the desired delay. The selected delay time value (up to 24 hours) will appear on the display for 3 seconds, then the duration of the programme will appear again.

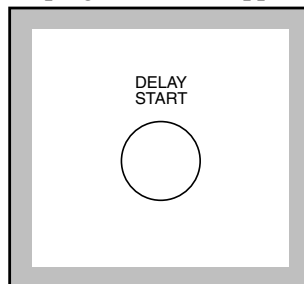

10. Start the programme

Press the START/PAUSE button. The relevant light will stop flashing, the DOOR LOCKED light will light up, and only the light relevant to the phase that is in progress will remain lit.

If you have chosen a delayed start, the washing machine will begin the countdown.

The display will show the duration of the programme or the selected delay.

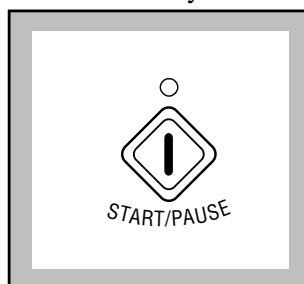

11. How to change a programme during its cycle

Before you make any change, you must pause the machine by pressing the START/PAUSE button.

It is possible to change any phase before the programme carries it out.

Changing the type of fabric or temperature is possible, obviously, only during the washing phase. When you make a change in these two parameters, the machine will resume the cycle **from the beginning**.

If it is necessary to drain the water in order to change the programme in progress, proceed as follows:

- PAUSE the machine by pressing the START/PAUSE button;
- press the SKIP/RESET button repeatedly, until only the DRAIN light remains lit;
- press the START/PAUSE button again.

When the water has been drained, the display shows a blinking zero. You may now select a new programme and press the START/PAUSE button to start it.

12. How to cancel a programme during its cycle

To cancel a programme that is being carried out, first pause the machine by pressing the START/PAUSE button, then press the SKIP/RESET button repeatedly, until the display shows **three blinking dashes**.

13. How to open the door during the cycle of a programme

You can open the door, after having set the machine to PAUSE, provided the following conditions exist:

- the washing machine is not in the heating phase beyond 55°C;
- the level of the water is not high;
- the drum is not turning.

If these requirements are met, when you pause the machine, the DOOR LOCKED light goes out and the door can be opened.

Should it not be possible to open the door, and should it be absolutely necessary to do so, switch the machine off by pressing the ON/OFF button.

After approximately 3 minutes, you can open the door.

Pay attention to the level and temperature of the water in the machine!

When you close the door and press the ON/OFF button again, the machine will resume the programme from the point where it had been interrupted.

14. End of programme

At the end of the programme, the machine stops automatically, gives an audible signal, and displays a blinking zero.

If you had selected the NIGHT WASH option, the START/PAUSE button light flashes to indicate that the water must be drained. The display shows a steadily lit zero.

When the programme has been completed, a blinking zero appears on the display and the audible signal is given.

The DOOR LOCKED light goes out at once.

Press the SKIP/RESET button repeatedly to erase the programme that has just been carried out. If you omit to do this, the next time you switch the machine on, the blinking zero will appear on the display and you will hear the audible signal.

Note: when you switch the machine on, if you must erase the previously performed programme, it is also sufficient to press the FABRIC button and select a new programme.

Press the ON/OFF button to switch the machine off. The relevant light will go out.

Remove the laundry from the machine.

Check whether the drum is completely empty, by rotating it with your hand. The purpose of this is to prevent any items of laundry from remaining accidentally in the drum, where they might get damaged in a subsequent wash (e.g. by shrinking) or bleed colour into another load of laundry.

We advise you to close the water supply tap and disconnect the plug from the socket.

Leave the door ajar in order to air the machine.

DRYING 3 KG OF COTTON

You have for example just machine-washed and spun at 1600 rpm 6 kg (12 lb) of laundry.

They are cotton fabrics of medium weight which you want to iron as soon as they are dry.

Press the SKIP/RESET button repeatedly to erase the programme that has just been carried out,  will show in the display and switch the machine off by depressing ON/OFF button.

Then remove the laundry from the appliance and divide the items to obtain two loads of approx. 3 kg (6 lb) each.

The water tap must be open and the drain hose must be positioned in the sink or connected to the drain pipe.

1. Load the laundry.
2. Depress the ON/OFF button to switch the machine on,  will show in the display.
3. If you wish to carry out the electronic drying, depress AUTO DRY button until the light IRON DRY illuminates.

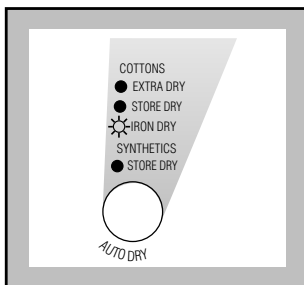

If you want a timed drying, depress the DRYING TIME button until the light COTTONS lights up, then depress the same button until the time you want appears on the display.

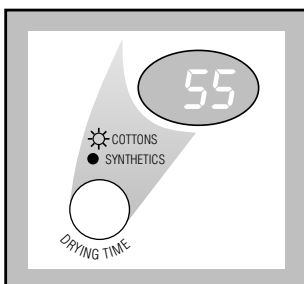

4. Press the START/PAUSE button to start the programme.

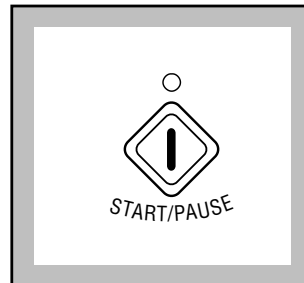

5. At the end of the programme press SKIP/RESET button to clear the memory and switch the machine off by depressing ON/OFF button.
6. Remove the laundry.

Note:

The programme time will automatically increase by up to 1 minute, this is quite normal.

AUTODRYING 2 KG OF SYNTHETICS

You intend to wash and dry automatically 2 kg (4.4 lb) of synthetics which do not need ironing.

Do not use a dosing device/ball when carrying out a washing & drying programme.

1. Load the laundry.
2. Add detergent and fabric softener.
3. Switch the machine on by depressing the ON/OFF button .
4. Select the wash programme/fabric and temperature.
5. Select the drying time or degree of drying.
6. Select the required options by means of the relevant buttons. If possible, do not select a spin speed lower than that proposed by the appliance to avoid a too long drying time so saving energy.
In any case the reduction of the spin speed is only possible after selecting drying. The lowest values you can select are the following:
 - 900 r.p.m. for cottons & synthetics with electronic drying
 - 900 r.p.m. for cottons and 700 r.p.m. for synthetics with timed drying
7. Start the programme by depressing the START/PAUSE button.
8. At the end of the programme press the SKIP/RESET button to clear the memory and press the ON/OFF button again to switch the machine off.
9. Remove the laundry.

Washing and Drying Hints

Do **NOT** overload the machine. Weigh the laundry the first few times you use the appliance.

The average weights of the most common items are listed below as a guide:

1000g = 1 kg

| | |
|----------------------|-------------|
| Sheet | 700-1000 g |
| Pillow case | 100-200 g |
| Tablecloth | 400-500 g |
| Serviette | 50-100 g |
| Tea towel | 70-120 g |
| Linen hand towel | 100-150 g |
| Towelling hand towel | 150-250 g |
| Towelling bath towel | 700-1000 g |
| Bath robe | 1000-1500 g |
| Man's shirt | 200-300 g |
| Apron | 150-200 g |

- Load the laundry loosely alternating large items with small ones.
- Sort the laundry according to the type of fabric, colour-fastness and how dirty it is.
- Avoid washing unhemmed or torn items as they may unravel.
- Before washing, empty all pockets of small objects which may have been left inside (coins, keys, screws etc). as these could damage the drain pump.
- When washing curtains, remove the hooks.
- Close poppers and zips and fasten loose buttons.
- It is essential to wash new coloured items separately when washing for the first time.
- When washing fabrics requiring different wash temperatures together, always select the lowest temperature.
- White items should not be washed with coloured items.
- Very small items (handkerchiefs, ribbons, socks etc) should be washed in a washing bag or a pillow case.
- Use a good quality detergent suitable for automatic washing machines.
- Use the correct quantities of detergent.
- For wool, use gentle detergent only in small quantities.
- Bleach is very corrosive; it should be used with care and kept out of reach of children.
- Some stains such as fruit, wine, grass, rust etc. are difficult to remove and should be treated before washing with specific products, which can be found in most household shops. In some cases it may help to soak the stain before washing with a special pre-soak product or biological detergent.
- If you have used the machine to wash, rinse or spin only non-colour fast garments, there may be dye left in the sump. To ensure any subsequent wash is not contaminated with the dye, select and carry out a rinse and spin programme, without any garments, to ensure that any dye is removed from the sump.
- Do not leave the damp laundry load in a heap too long before drying.
- Avoid drying dark clothes with light coloured fluffy items such as towels as these can attract the fluff.
- If you overdry the laundry, besides wasting energy, any subsequent ironing may become more difficult because the fabric could be heavily crumpled.
- Remove the laundry when the appliance has finished drying.
- To avoid a static charge when drying is completed, use either a fabric softener when you are washing the laundry or a fabric conditioner specifically for tumble dryers.
- Particularly delicate items such as synthetic curtains, woollen and silk, garments with metal inserts, nylon stockings, bulky garments such as anoraks, bedcovers, quilts, sleeping bags and duvets must not be machine dried.
- Garments padded with foam-rubber or materials similar to foam-rubber must not be machine dried; they represent a fire hazard.
- Also, fabrics containing residues of setting lotions or hair sprays, nail solvents or similar solutions must not be machine dried in order to avoid the formation of harmful vapours.
- For drying, follow the indications given on the manufacturer's labels.
 - May be tumble dried
 - Drying at high temperature
 - Drying at reduced temperature
 - Do not tumble dry

Important:

As a dryer, the machine works on the condensation principle.

Therefore, the water taps must be open and the drain hose must drain water into a sink or into the drain pipe, even during the drying cycle.

Which detergent?....

To ensure you obtain the best wash results from your appliance, it is important to use the right detergent in your everyday wash, and only detergents recommended for use in automatic machines.

To maintain the appearance of your clothes and household textiles and to make them last longer you should use different types of detergent for different washes, whether for whites, colours or delicates.

WHITES

We recommend the Ariel product range which is biological and designed to provide excellent cleaning and stain removal even at low temperatures.



NON BIOLOGICAL

If you prefer to use a non biological detergent, which does not contain enzymes we recommend Fairy. Fairy provides good cleaning and stain removal.



COLOURED

For coloured items you should use a detergent which is designed to clean while maintaining the original colour. Ariel Color does not contain bleach and therefore helps to preserve colours.



DELICATE ITEMS

When washing delicates such as woollens, you should use a product which is specially designed to care for fine fabrics.

Dreft Automatic is suitable for woollens and other delicates.

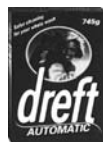

LAUNDRY BLEACH

For additional stain removal you may wish to use a product such as Ace Gentle Bleach which is used in addition to your chosen detergent. Ace is suitable for all washable fabrics including silks, woollens and coloureds.



And in which form?

Not only are there different types of detergent, but they are also available in different forms. Whether you chose a powder or liquid in traditional or compact form is your own personal choice.

TRADITIONAL POWDERS

Pour the powder directly into the dispenser drawer. Do not sprinkle powder onto clothes in the machine drum.

TRADITIONAL LIQUIDS

Liquid can be placed in the main wash compartment of the detergent drawer marked with the symbol , start the machine immediately upon placing the detergent in the dispenser drawer.

Alternatively the detergent is measured into the specially designed dosing device* which should be placed on top of the laundry, and at the back of the machine drum.

COMPACT POWDERS AND LIQUIDS

Compact detergents (or concentrates as they are also known) are available in liquid or powder form, and generally require a smaller dosage. Follow the manufacturer's instructions to ensure the most economical usage. Pour the detergent directly into the dispenser drawer, or alternatively measure the detergent into the specially designed dosing device* which should be placed on top of the laundry, and at the back of the machine drum.

* **If you use a dosing device in a washer dryer, please ensure the dosing device/ball is removed before carrying out a drying programme.**

FABRIC CONDITIONERS

These are ideal for improving 'softness', and also reduce static cling on synthetics and make ironing easier. They are available in two types:

For example Lenor liquid fabric softener, for use in the **washing machine/washer dryer**. The liquid fabric softener should be poured into the compartment marked with the symbol . Follow the manufacturer's dosage instructions and never exceed the MAX level.



















Bounce conditioning sheets for use in a **tumble dryer**. We recommend the conditioning sheets are pinned (using a safety pin) to an article of laundry and placed in the tumble dryer.



Wash Care Symbols

Wash care labels inside garments recommend how to launder your clothes with the best results. The care labelling code is in line with care labelling used in the rest of Europe. The symbols used make it easy to select the correct programme on your washing machine.







| WASHING SYMBOL | WASH ACTION | FABRIC |
|---|--|---|
|  | Normal (Maximum) | White Cotton or Linen without Special Finishes |
|  | Normal (Maximum) | Cotton, Linen or Viscose without Special Finishes Colourfast at 60°C. |
|  | Reduced (Medium) | Nylon, Polyester/Cotton, Viscose with Special Finishes, Cotton/Acrylic Mix. |
|  | Normal (Maximum) | Cotton, Linen or Viscose Colourfast at 40°C but not 60°C. |
|  | Reduced (Medium) | Acrylics, Acetate, Triacetate, Wool mixes, Polyester/wool blends. |
|  | Much Reduced (Minimum) | Wool, wool mixtures, Silks |
|  | Hand wash only | Do not machine wash |
| BLEACHING | | |
|  | Chlorine bleach may be used | |
| IRONING | | |
|  | Hot iron | Cotton, Linen, Viscose |
|  | Warm iron | Polyester mixtures, Wool |
|  | Cool iron | Acrylic, Nylon, Polyester |
| DRY CLEANING | | |
|  | May be dry cleaned. Other letters and/or a bar beneath the circle will indicate the required process to the dry cleaner. | |
| TUMBLE DRYING | | |
|  | with high heat setting | |
|  | with low heat setting | |
|  | May be tumble dried | |
|  | A cross through any symbol means «DO NOT» | |

Important Notes

For best results, always use the dispenser drawer for dispensing detergents and liquid additives. Once the dispenser has been filled, close it by pushing it in gently. This is particularly important if you are using

fabric conditioner to avoid the conditioner entering the machine prematurely. When using liquid detergent and a prewash programme, place the detergent into the correct compartment in the dispenser drawer, after the prewash has finished.

Washing programmes

| Type of laundry and symbols on labels | Load | Programme/temperature | Description of programme | Available options | Consumption* | | |
|---|------|--------------------------------|---|--|--------------|--------------|-------------|
| | | | | | Energy kWh | Water litres | Time h/min. |
|  White cotton: e.g. sheets, tablecloths, household linen | 6 kg | Cottons 60°-90°C | Main wash at 60°-90°C 3 rinses Long spin | SPIN SPEED NIGHT WASH PREWASH AA40° QUICK WASH | 2.0 | 55 | 2.41 |
|  Coloured cotton: e.g. shirts, blouses, underwear, towels, household linen | 6 kg | Cottons 60°-50°-40°-30°C | Main wash at 60°-50°-40°-30°C 3 rinses Long spin | SPIN SPEED NIGHT WASH PREWASH AA40° QUICK WASH | 1.14 | 52 | 2.17 |
|  Synthetic fabrics and blends: e.g. shirts, blouses, underwear | 3 kg | Synthetics 60°-50°-40°-30°C | Main wash at 60°-50°-40°-30°C 3 rinses Short spin | SPIN SPEED NIGHT WASH PREWASH AA40° QUICK WASH | 1.0 | 55 | 1.36 |
|  Delicate fabrics: e.g. acrylic fabrics, viscose, polyester, synthetic blends | 3 kg | Delicates 40°-30°C | Main wash at 40°-30°C 3 rinses Short spin | NIGHT WASH PREWASH QUICK WASH | 0.55 | 60 | 1.07 |
|  Wool | 2 kg | Wool 40°-30°C | Main wash at 40°-30°C 3 rinses Short spin | SPIN SPEED NIGHT WASH | 0.4 | 63 | 55 |
|  | 2 kg | Hand wash 40°-30°C | Main wash at 40°-30°C 3 rinses Short spin | SPIN SPEED NIGHT WASH | 0.4 | 63 | 58 |

The “coloured cotton programme” at 60°C is the reference programme for the data entered in the energy label, in compliance with EEC 92/75 standards.

* This data is given purely as an indication: the consumption values may vary in relation to the quantity and type of laundry, the temperature of the water supply and the ambient temperature. The data refers to the highest temperature provided for each programme.

Drying Programmes

Timed drying

| Degree of drying | Type of fabric | Max. load | Spin speed | Drying time mins |
|---|--|-----------|------------|------------------|
| Extra dry Ideal for towelling materials | Cotton and linen (bathrobes, bath towels, etc.) | 3 kg | 1200 | 90-100 |
| | | | 1600 | 80-90 |
| | | 1.5 kg | 1200 | 55-65 |
| | | | 1600 | 45-55 |
| Store dry (*) Suitable for items to put away without ironing | Cotton and linen (towels, T-shirts, bathrobes) | 3 kg | 1200 | 80-90 |
| | | | 1600 | 70-80 |
| | | 1.5 kg | 1200 | 45-55 |
| | | | 1600 | 35-45 |
| | Synthetics and mixed fabrics (jumpers, blouses, underwear, household linen) | 2 kg | 900 | 70-80 |
| | | 1 kg | 900 | 35-45 |
| Iron dry Suitable for ironing | Cotton and linen (sheets, tablecloths, shirts, etc.) | 3 kg | 1200 | 60-70 |
| | | | 1600 | 50-60 |
| | | 1.5 kg | 1200 | 40-50 |
| | | | 1600 | 30-40 |

(*) The STORE DRY drying programme for cotton is the reference programme for the Energy Label data, in compliance with EC directive 92/75.

Maintenance and Cleaning

Before any maintenance or cleaning is carried out you must **DISCONNECT** the appliance from the electricity supply.

Descaling

The water we use normally contains lime. It is a good idea to periodically use a water softening powder in the machine. Do this separately from any laundry washing, and according to the softening powder manufacturer's instructions. This will help to prevent the formation of lime deposits.

After each wash

Leave the door open for a while. This helps to prevent mould and stagnant smells forming inside the appliance. Keeping the door open after a wash will also help to preserve the door seal.

Maintenance Wash

With the use of low temperature washes it is possible to get a build up of residues inside the drum. We recommend that a maintenance wash be performed on a regular basis.

To run a maintenance wash:

- The drum should be empty of laundry.
- Select the hottest cotton wash programme.
- Use a normal measure of detergent, must be a powder (such as Ariel Futur).

External cleaning

Clean the exterior cabinet of the appliance with soap and water only, and then dry thoroughly.

Cleaning the dispenser drawer

The washing powder and additive dispenser drawer should be cleaned regularly.

Remove the drawer by pressing the catch downwards and by pulling it out. Flush it out under a tap, to remove any traces of accumulated powder.

To aid cleaning, the top part of the additive compartment should be removed.

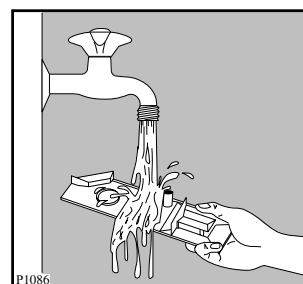
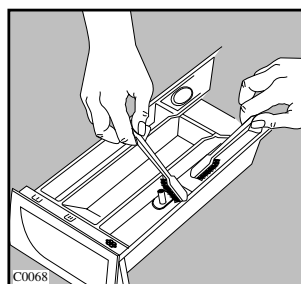
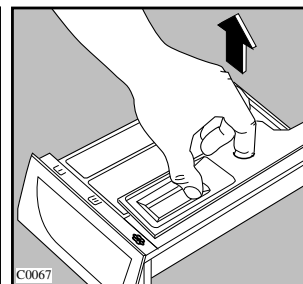
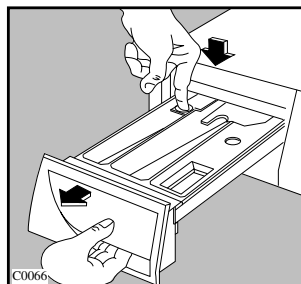

Cleaning the drawer recess

Having removed the drawer, use a small brush to clean the recess, ensuring that all washing powder residue is removed from the upper and lower part of the recess. Replace the drawer and run the rinse programme without any clothes in the drum.

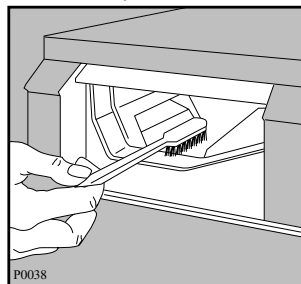

Cleaning the filter

The water drain filter

A clean filter is important for the correct functioning of the machine, and should therefore be cleaned after every washing programme.

Open the filter door and place a container underneath to catch any spillage.

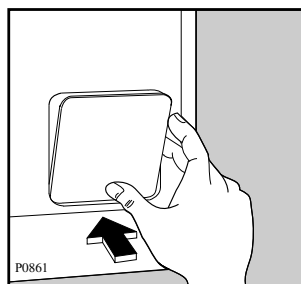

If the filter is blocked and the machine is unable to drain you will need to drain the water manually from the machine at this stage. To do this, unhook the drain hose from the standpipe or sink and hold the end of the hose over a bowl on the floor. The water should drain by gravity into the bowl. When the bowl is full, hook the hose back up and empty the bowl. Repeat the procedure until water stops flowing out.

Unscrew and remove the filter.

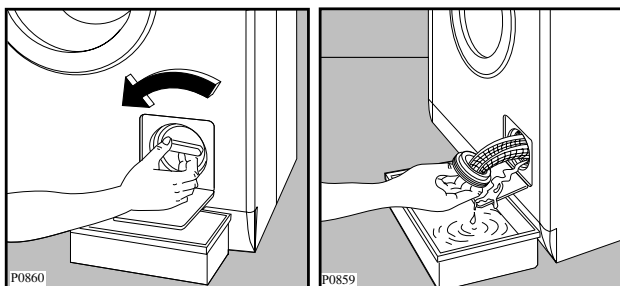

Clean carefully under a fast running tap.

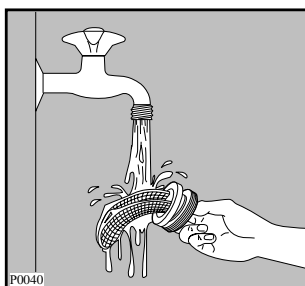

Warning

When the appliance is in use and depending on the programme selected there can be hot water in the filter. Never remove the filter during a wash cycle, always wait until the appliance has finished the cycle, and is empty. When replacing the filter, ensure it is securely retightened so as to stop leaks and young children being able to remove it.

The water inlet filter

If your water is very hard or contains traces of lime deposit, the water inlet filter may become clogged.

It is therefore a good idea to clean it from time to time.

Turn off the water tap. Unscrew the water inlet hose. Clean the filter using a hard bristle brush. Tighten up the inlet hose.

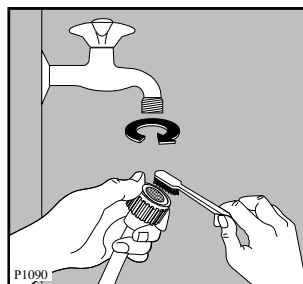

The dangers of freezing

If the machine is exposed to temperatures below 0°C, certain precautions should be taken.

- Turn off the water tap.
- Unscrew the inlet hose.
- Unhook the drain hose from the rear support and position the end of this hose and that of the inlet hoses in a bowl. Run the draining programme.

To do this:

- Switch the machine on
- Select a washing programme
- Press the SKIP/RESET button three times
- Press START/PAUSE button
- Disconnect the appliance.
- Screw the inlet hose and reposition the drain hose.
- When you intend to start the machine up again, make sure that the room temperature is above 0°C.

Something Not Working

Certain problems are due to lack of simple maintenance or oversights, which can be solved easily without calling out an engineer. Before contacting your local Service Force Centre, please carry out the checks listed below.

IMPORTANT: if you call out an engineer to a fault listed below, or to repair a fault caused by incorrect use or installation, a charge will be made even if the appliance is under guarantee.

During machine operation it is possible that one of the following alarm codes appears on the display:

- **E10** : problem with the water supply
- **E20** : problem with water draining
- **E40** : door open

Once the problem has been eliminated, press the START/PAUSE button  to restart the programme. If after all checks, the problem persists, contact your local Service Force Centre.

| Symptom | Possible causes |
|---|---|
| The machine does not start | <ul style="list-style-type: none"> ● The door has not been closed. (E40) ● The plug is not properly inserted in the power socket. ● There is no supply at the socket. ● The main fuse or the fuse in the plug has blown. ● The START/PAUSE button has not been depressed. ● The DELAY START option has been selected. |
| The machine does not fill | <ul style="list-style-type: none"> ● The water tap is closed. (E10) ● The filter in the inlet hose is blocked. (E10) ● The inlet hose may be squashed or kinked. (E10) ● The door has not been closed. (E40) |
| The machine fills then empties immediately | <ul style="list-style-type: none"> ● The end of the drain hose is too low. ● The end of the drain hose is submerged in water. ● There is no vent in the end of the drain hose. |
| The machine does not empty and/or does not spin | <ul style="list-style-type: none"> ● The drain hose may be squashed or kinked. (E20) ● The NIGHT WASH option has been selected. ● The drain filter may be blocked. (E20) ● The drain hose extension, if fitted, is not correct. Follow the instructions for connecting to the waste. ● The drainage system pipes are blocked. ● The wash load is unbalanced: redistribute the clothes inside the drum to allow the machine to spin. |
| There is water on the floor | <ul style="list-style-type: none"> ● Too much detergent or unsuitable detergent has been used (creates too much foam). ● Check whether there are any leaks from the inlet hose fittings. It is not always easy to see this as the water runs down the hose; check to see if it is damp. ● The drain hose may be damaged or not securely positioned. ● The detergent dispenser drawer or recess is clogged. ● The drainage system pipes are blocked. |
| Unsatisfactory washing results | <ul style="list-style-type: none"> ● Too little detergent or unsuitable detergent has been used. An insufficient amount of detergent leaves the laundry looking grey and causes lime scale to form. ● Stubborn stains have not been treated prior to washing ● The correct wash programme/temperature has not been selected. ● Too much laundry has been placed in the drum. |

| Symptom | Possible causes |
|--|---|
| The machine vibrates when spinning | <ul style="list-style-type: none"> • The internal packing has not been removed. • The machine is in contact with the wall or furniture. • The machine is not level and stable (check diagonally). • The washing load is badly distributed in the drum. • Maybe there is very little laundry in the drum. |
| The door will not open | <ul style="list-style-type: none"> • The water level is above the bottom edge of the door. • The machine is heating the water or drying the clothes. • The drum is turning. <p>The door can only be opened when the relevant light has gone out.</p> |
| Spinning starts late or the machine does not spin | <ul style="list-style-type: none"> • The electronic unbalance detection device has cut in because the laundry is not evenly distributed in the drum. The laundry is redistributed by reverse rotation of the drum. This may happen several times before the unbalance disappears and normal spinning can resume. If, after few minutes, the laundry is still not evenly distributed in the drum, the machine will spin at a lower spin or will not spin. In this case, redistribute the load manually and select the spin programme. |
| The machine makes an unusual noise | <ul style="list-style-type: none"> • The machine is fitted with a type of motor which makes an unusual noise compared with other traditional motors. This new motor ensures a softer start and more even distribution of the laundry in the drum when spinning, as well as increased stability of the machine. |
| No water is visible in the drum | <ul style="list-style-type: none"> • Machines based on modern technology operate very economically using very little water without affecting performance. |
| The machine does not dry or does not dry properly | <ul style="list-style-type: none"> • The drying time or degree of drying has not been selected • The water tap is not turned on (E10) • The drain filter is clogged (E20) • The machine is overloaded • The selected drying time or degree of dryness was not suitable for the laundry |

Service & Spare Parts **SERVICE FORCE**

In the event of your appliance requiring service, or if you wish to purchase spare parts, please contact your local Service Force Centre by telephoning:

0870 5 929929

Your telephone call will be automatically routed to the Service Force Centre covering your post code area.

For the address of your local Service Force Centre and further information about Service Force, please visit the website at www.serviceforce.co.uk.

For Customer Service in Ireland please contact us at the address below:

Zanussi Electrolux
Electrolux Group (Irl) Ltd
Long Mile Road
Dublin 12
Republic of Ireland

Tel: +353 (0)1 4090751

Email: service.eid@electrolux.ie

Before calling out an engineer, please ensure you have read the details under the heading "Something Not Working".

When you contact the Service Force Centre you will need to give the following details:

1. Your name, address and post code
2. Your telephone number
3. Clear and concise details of fault
4. The model and serial number of the appliance (found on the rating plate - see picture)
5. The purchase date.

Please note that a valid purchase receipt or guarantee documentation is required for in-guarantee service calls.

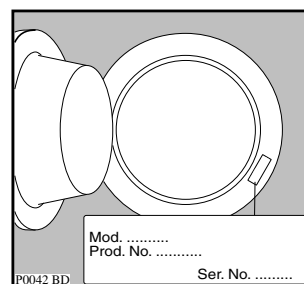

Customer Care Department

For general enquiries concerning your Zanussi Electrolux appliance or for further information on Zanussi Electrolux products, please contact our Customer Care Department by letter or telephone at the address below or visit our website at www.zanussi.co.uk

Customer Care Department

Zanussi Electrolux
55-77 High Street
Slough
Berkshire
SL1 1DZ
Tel 08705 727727*

* calls to this number may be recorded for training purposes.

Guarantee Conditions

Standard guarantee conditions

We, Zanussi Electrolux, undertake that if, within 12 months of the date of the purchase, this ZANUSSI ELECTROLUX appliance or any part thereof is proved to be defective by reason only of faulty workmanship or materials, we will, at our option repair or replace the same FREE OF ANY CHARGE for labour, materials or carriage on condition that:

- The appliance has been correctly installed and used only on the electricity supply stated on the rating plate.
- The appliance has been used for normal domestic purposes only, and in accordance with the manufacturer's instructions.
- The appliance has not been serviced, maintained, repaired, taken apart or tampered with, by any person not authorised by us.
- All service work under this guarantee must be undertaken by a Service Force Centre.
- Any appliance or defective part replaced shall become the Company's property.
- This guarantee is in addition to your statutory and other legal rights.

Home visits are made between **8.30am** and **5.30pm** Monday to Friday. Visits may be available outside these hours in which case a **premium** will be charged.

Exclusions

This guarantee does not cover:

- Damage or calls resulting from transportation, improper use or neglect, the replacement of any light bulbs or removable parts of glass or plastic.
- Costs incurred for calls to put right an appliance which is improperly installed or calls to appliances outside the United Kingdom.

- Appliances found to be in use within a commercial environment, plus those which are subject to rental agreements.
- Products of Zanussi Electrolux manufacture which are NOT marketed by Zanussi Electrolux.

European guarantee

If you should move to another country within Europe then your guarantee moves with you to your new home subject to the following qualifications:

- The guarantee starts from the date you first purchased your product.
- The guarantee is for the same period and to the same extent for labour and parts as exists in the new country of use for this brand or range of products.
- The guarantee relates to you and cannot be transferred to another user.
- Your new home is within the European Community (EC) or European Free Trade Area.
- The product is installed and used in accordance with our instructions and is only used domestically, i.e. a normal household.
- The product is installed taking into account regulations in your new country.

Before you move please contact your nearest Customer Care Centre, listed below, to give them details of your new home. They will then ensure that the local Service Organisation is aware of your move and able to look after you and your appliances.

| | | |
|---------|-----------|----------------------|
| France | Senlis | +33 (0) 344 62 29 29 |
| Germany | Nurnberg | +49 (0) 800 234 7378 |
| Italy | Pordenone | +39 0434 39 4700 |
| Sweden | Stockholm | +46 (0) 8 672 53 90 |
| UK | Slough | +44 (0) 1753 219897 |
| Ireland | Dublin | +353 (0)1 4090751 |

Installation Instructions

- ⚠ It is dangerous to alter the specifications or attempt to modify this product in any way.
- ⚠ Care must be taken to ensure that the appliance does not stand on the electrical supply cable.
- ⚠ Any electrical work required to install this appliance should be carried out by a qualified electrician or competent person.
- ⚠ Any plumbing work required to install this appliance should be carried out by a qualified plumber or competent person.
- ⚠ Should the appliance power supply cable need to be replaced, this should be carried out by our Service Force Centre.

Technical Specifications

| | | |
|--|---|--|
| DIMENSIONS | Height Width Depth | 85 cm 60 cm 57 cm |
| POWER SUPPLY VOLTAGE TOTAL POWER ABSORBED | | 230-240 V/50 Hz 2050 W (10A) |
| WATER PRESSURE | Minimum Maximum | 50 kPa 800 kPa |
| MAX LOAD CAPACITY | Washing Cotton, linen Synthetics Delicate fabrics Wool and Hand Wash Drying Cotton, linen Synthetics | 6 kg 3 kg 3 kg 2 kg 3 kg 2 kg |
| SPIN SPEED | Maximum | 1600 rpm |
| CONSUMPTION DATA FOR WASHING 6 KG NORMALLY SOILED COTTON ITEMS AT 60°C | Energy Water | 1.14 kWh 52 litres |

- ⒸⒺ This appliance complies with the following E.E.C. Directives:
- 73/23 EEC of 19.2.73 (Low Voltage Directive) and subsequent modifications;
 - 89/336 EEC of 3.5.89 (Electromagnetic Compatibility Directive) and subsequent modifications.

Unpacking

 All transit bolts and packing must be removed before using the appliance.

You are advised to keep all the packaging for re-use in case the machine is to be transported again.

1. Using a spanner, unscrew and remove the two rear bottom screws. Slide out the two plastic pins. Lay the machine on its back, taking care not to squash the hoses. This can be avoided by placing one of the corner packing pieces between the machine and the floor.

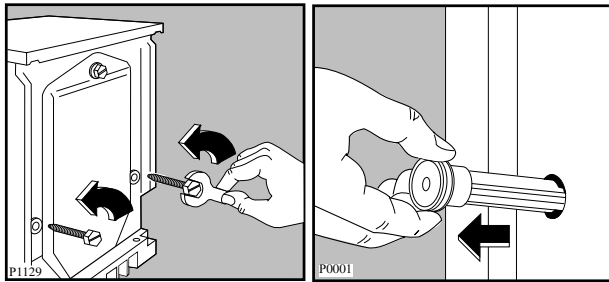

2. Remove the polystyrene blocks from the bottom of the machine and release the two plastic bags.

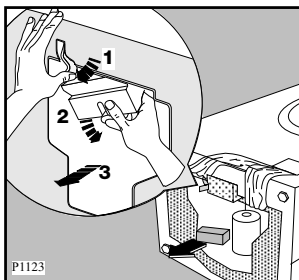

3. Very carefully slide out the left polythene bag, removing it towards the right and then downwards.
4. Very carefully slide out the right polythene bag, removing it towards the left and then upwards.

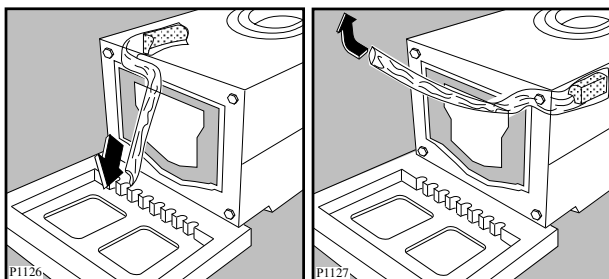

5. Set the machine upright and remove the remaining rear screw. Slide out the relevant pin.

6. Plug all the holes with the plugs which you will find in the envelope containing the instruction booklet.

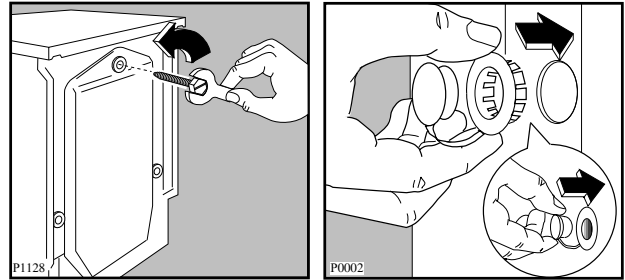

Positioning

Install the machine on a flat hard floor.

Make sure that air circulation around the machine is not impeded by carpets, rugs etc. Check that the machine does not touch the wall or other kitchen units.

Never place cardboard, wood or similar materials under the machine to compensate for any unevenness in the floor.

Your new washing machine has been designed to be permanently plumbed in to your home's water supply and drainage system. However, if this is not possible, it may be connected to a suitable existing tap with the drain hose discharging into a sink.

The appliance has an inlet hose, with female 3/4" BSP thread connector. If this connection is not compatible with the plumbing of the existing installation, a variety of connectors are available from good hardware stores and plumbers merchants to suit most domestic plumbing. Any alteration to your existing plumbing must be carried out by a competent person, or qualified plumber.

Installation on a Suspended Floor

Suspended wooden floors are particularly susceptible to vibration. To help prevent vibration we recommend you place a waterproof wood panel, at least 15 mm thick under the appliance, secured to at least 2 floor beams with screws. If possible install the appliance in one of the corners of the room, where the floor is more stable.

Water inlet

Connect the hose supplied with the machine to a tap with a 3/4" thread.

Do not use already employed hoses.

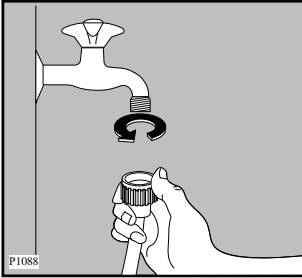

Installation should comply with local water authority and building regulations' requirements.

The appliance must be connected to a cold water supply.

A minimum water pressure of 50 kPa (0.5 bar) is required for safe operation of the appliance.

If you cannot make the cold water connection direct from the rising mains, you may be able to operate the appliance from your cold water storage system.

There should be a minimum distance of 5.02m (16 1/2 ft) between the appliance's inlet and the bottom of the water storage tank.

Set the hose correctly by loosening the ring nut. After positioning the inlet hose, be sure to tighten the ring nut again to prevent leaks.

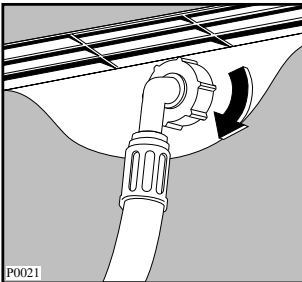

Water drainage

This appliance is designed to be permanently plumbed into your home's water supply and drainage system.

The appliance drain hose should hook into a standpipe, the hook in the drain hose is formed using the plastic "U-Piece" supplied.

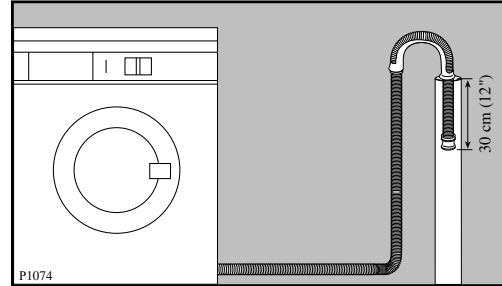

The standpipe should have an internal diameter of approximately 38mm (see diagram) thus ensuring there is an air break between the drain hose and standpipe.

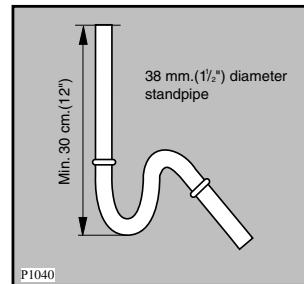

When discharging into a standpipe ensure that the top of the curve in the hose end is no more than 90cm (35.4") and no less than 60cm (23.6") above floor level. The upright standpipe should have a minimum length of 30cm (12") from the bottom of the elbow to the top of the pipe (see diagram).

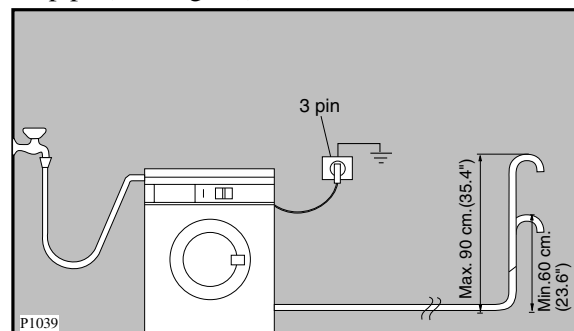

Make sure that it is designed in such a way, that the end of the drain hose cannot be covered with water. The drain hose may be extended to a maximum of 4 metres. An additional drain hose and joining piece is available from your local Service Force Centre. The joining piece must have an internal diameter of 18mm.

If you intend the drain hose to empty into a sink, make sure that the sink is empty and the plug hole is not blocked. Use the plastic “U-Piece” supplied.

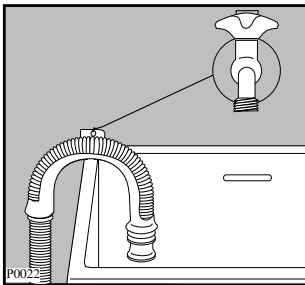

Important

Before connecting up the machine to new pipework or to pipework that has not been used for some time, run off a reasonable amount of water to flush out any debris that may have collected in the pipes.

Levelling

Level the washing machine by raising or lowering the feet. The feet may be tight to adjust as they incorporate a self locking nut, but the machine **MUST** be level and stable (check diagonally).

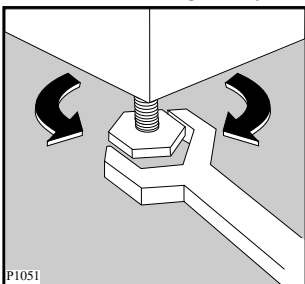

Any necessary adjustment can be made with a spanner. Accurate levelling prevents vibration, noise and displacement of the machine during operation.

Some vibration is inevitable, especially if mounted on a wooden floor.

Sprung wooden floors are particularly susceptible to vibration. For advice, consult a builder. If possible, always place the machine on a solid floor.

Special conditions

If the floor is carpeted or covered with crumbly or soft material, insert a rigid support base under the feet to prevent noise, vibration or displacement. The base should protrude a few centimetres beyond the edges of the machine.



Warning

The machine should **NOT** be placed on deep pile carpeting.

Note

Please ensure that when the appliance is installed it is easily accessible for the engineer in the event of a breakdown.

In the interest of the environment

Washing machines and dishwashers should be connected to the FOUL drainage system, the water will then be taken to a sewage works for treatment before being discharged safely into a river.

It is essential that these appliances are not connected to the surface water drainage system as this water is discharged directly into a river or stream and may cause pollution.

If you require any further advice please contact your local water authority.

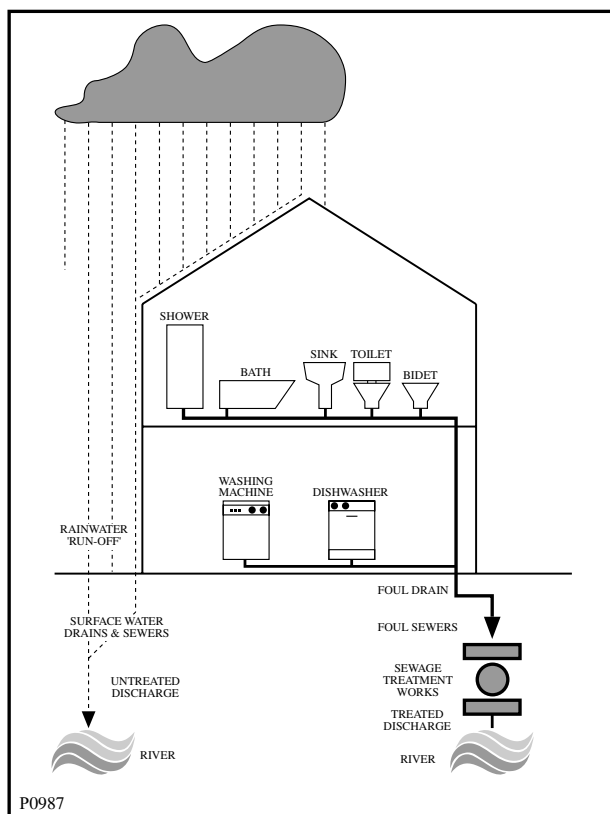

Electrical connection

Any electrical work required to install this appliance should be carried out by a qualified electrician or competent person.

! WARNING: THIS APPLIANCE MUST BE EARTHED.

The manufacturer declines any liability should this safety measure not be observed.

Before switching on, make sure the electricity supply voltage is the same as that indicated on the appliance's rating plate. The rating plate is located at the top of the rim of the open door.

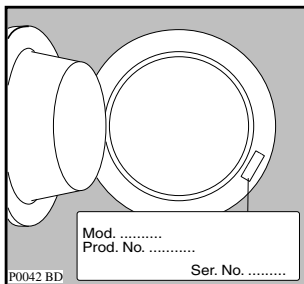

The appliance is supplied with a 13amp plug fitted. In the event of having to change the fuse in the plug supplied, a 13amp ASTA approved (BS1363/A) fuse must be used.

Should the plug need to be replaced for any reason, proceed as described below.

The wires in the mains lead are coloured in accordance with the following code:

- | | |
|------------------|-----------|
| Green and Yellow | - Earth |
| Blue | - Neutral |
| Brown | - Live |

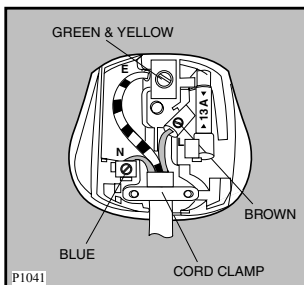

The wire coloured green and yellow must be connected to the terminal marked with the letter «E» or by the earth symbol \perp or coloured green and yellow.

The wire coloured blue must be connected to the terminal marked «N» or coloured black.

The wire coloured brown must be connected to the terminal marked «L» or coloured red.

Upon completion there must be no cut, or stray strands of wire present and the cord clamp must be secure over the outer sheath.

! WARNING:
A cut off plug inserted into a 13 amp socket is a serious safety (shock) hazard.
Ensure that the cut off plug is disposed of safely.

Should the appliance power supply cable need to be replaced, this should be carried out by our Service Force Centre.

Note

When the appliance is installed the power supply cable must be accessible.

Permanent connection

In the case of permanent connection it is necessary that you install a double pole switch between the appliance and the electricity supply (mains), with a minimum gap of 3mm between the switch contacts and of a type suitable for the required load in compliance with the current electrical regulations.

The switch must not break the yellow and green earth cable at any point.

 **From the Electrolux Group. The world's No. 1 choice.**

The Electrolux Group is the world's largest producer of powered appliances for kitchen, cleaning and outdoor use. More than 55 million Electrolux Group products (such as refrigerators, cookers, washing machines, vacuum cleaners, chain saws and lawn mowers) are sold each year to a value of approx. USD 14 billion in more than 150 countries around the world.